

Variable and multi-speed batch centrifugal drives.

**G.L.Grimwood. G.C.Grimwood. G.Hindle.
Broadbent Ltd.**

Abstract.

The two basic types of induction motor drives - fixed frequency mains supplied and variable frequency inverter supplied - are examined as centrifugal drives and their advantages and disadvantages compared and, where possible, quantified. Brief comments on process aspects that affect the drive and overall centrifugal efficiency are also included.

Introduction.

For many years developments in motors and controls have provided a variety of induction motor drive systems for batch sugar centrifugals [Ref 1]. These include motors with 2 or 3 windings each providing a different speed when supplied by a standard three phase supply. Limited regenerative electrical braking is provided by drives of this type. Since the widespread introduction of reliable power electronic devices over 20 years ago the growth of inverter technology has formed the basis of an entirely new drive concept. This provides the induction motor with a 'variable' supply giving control of both motor torque and speed over a wide range with a reduction in net power usage.

Although inverter supplied centrifugal drives have been in use for over 15 years the bulk of the batch sugar centrifugals in use today are still driven by multi-speed induction motors. Increasingly these older units are being replaced, and new factories are installing inverter drives, particularly when larger centrifugals are required. Rapid inverter developments have produced an attractive drive system that has allowed larger centrifugals to be developed (above 1.5 tonnes masecuite capacity). Since the introduction of inverter drives significant improvements have also been made to multi-speed motors to give both an alternative, simpler and cheaper drive for medium sized batch centrifugals and, if needed, low cost conversion to inverter drive at a later date.

Firstly in the following sections, the unconventional pattern of cyclic energy flow in batch centrifugal drives is outlined. Secondly the pro's and con's of multi-speed motors and inverter driven motors are assessed to assist in comparing the net economic advantages on batch centrifugal duties. Thirdly site experience on both types is compared.

Centrifugal drive requirements.

The drive for a batch centrifugal, figure 1, presents an intriguing problem. The cyclic duty of the centrifugal process requires acceleration from low (discharge) speed through feeding of the masecuite to spin for separation, followed by deceleration to low speed for discharge - typical cycle times are shown in Appendix A.

A large amount of energy is needed to accelerate the centrifugal and most of it is stored in the rotating loaded basket. The energies involved are large - a medium sized centrifugal spinning at 1200 rpm has the same stored energy as a 1.5 tonne motor car travelling at 160 mph (250 kph). If a proportion of this stored energy can be returned to the supply during deceleration then the net energy demand is reduced pro rata. As the centrifugal commences and ends the cycle at the same

discharge speed, the energy input has either been recovered by regeneration or dissipated in the losses in the system (controls + motor + windage & friction + energy lost to spun off syrup). Thus the net energy input, that is the energy input minus the energy recovered, equals the system losses. This applies equally to multi-speed and inverter drives. An indication of the loss pattern is given in Appendix B.

Fig 1. Schematic of typical batch centrifugal.

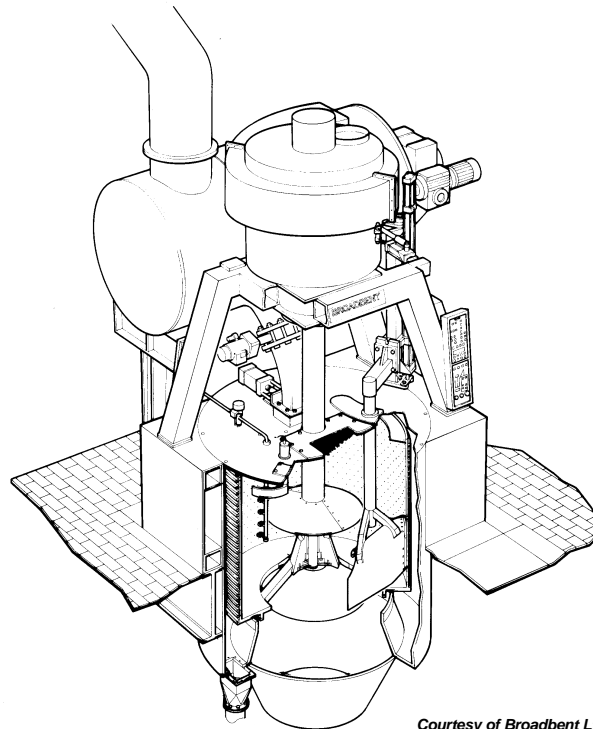

Courtesy of Broadbent Ltd.

Induction motor drives.

The cage type induction motor on a fixed frequency supply is used extensively throughout industry, being of relatively low cost, of simple construction, highly developed and reliable. With some exceptions these motors are made to operate at high efficiency at (or near) the 'full load' rating for lengthy periods and be capable at start-up of accelerating rapidly to speed without excessive power demand thereafter delivering mechanical power at near constant speed to the load. A wide variety of designs exist to cater for short time ratings, ambient conditions, supply restraints, load characteristics etc. with the main criteria being efficient and reliable operation at full load.

Generally the load driven by an industrial induction motor (conveyor, pump, machine tool, etc.) requires a known torque and the drive motor supplies this, which is a fraction of the substantial torque available in its overload range. The centrifugal, however, is a large flywheel load (very high inertia - many times higher than that of a typical fan) with negligible friction, demanding full motor power for acceleration over a wide speed range. If the motor is capable of deceleration by regeneration then similar conditions apply - but the power is now 'output' to the supply. To achieve the maximum processing of the centrifuged product the drive is designed to give minimum accelerating and decelerating times consistent with the allowable power demand, using the full motor torque available, not the 'full load' fraction.

The comparison is best emphasised by the fact that at full speed the industrial motor is designed and usually required to delivered 100% rated power whereas the centrifugal drive requirement is for negligible power at spin speed - typically 5% of the required during acceleration.

For a typical centrifugal operation (15-25 cycles per hour) the motor will be accelerating plus decelerating about 30-50% of the time. For the remaining 70-50% the centrifugal is feeding, spinning or discharging when the torque demand and motor input power is low. The motor operates at maximum torque for 30-50% of the cycle and minimum torque for the remainder, the motor rating for temperature rise being the mean load over the cycle.

Summarising, briefly the differences between industrial and centrifugal motor types are:

Motor type	Industrial	Centrifugal
Torque requirement	mechanical load at full speed	acceleration & braking time in process cycle.
Efficiency	electrical input ÷ mechanical output	massecuite processed per unit of electrical energy

The commonly used figure of kW hours used per tonne of massecuite processed is a measure of the centrifugal drive inefficiency.

The industrial motor with an input of 100 electrical units and an efficiency of 85% gives 85 units of mechanical energy (torque x speed x time) to deliver fluid pumped, metal cut or sheets rolled, etc. The centrifugal motor with 100 electrical units input returns 85 electrical units to the supply, and the 'stationary' massecuite fed to the centrifugal has been separated into 'stationary' sugar and 'stationary' molasses. In both cases 15% of the input has been lost but measures of efficiencies and ratings differ widely as do the overall design criteria for industrial and batch sugar centrifugal drive motors. In the following sections it is the induction motors developed specifically to match the centrifugal duty cycle that are being considered.

Historical note.

Originally centrifugals were driven by single speed fixed frequency induction motors (some small centrifugals are still driven this way). Being unable to regenerate power, deceleration is generally by some form of mechanical brake. With no energy recovery this arrangement is extremely inefficient and unacceptable.

To increase efficiency two speed motors were developed, usually with a 2:1 speed ratio from a single tapped winding. This allows the low speed winding to regenerate from spin to approaching half speed, recovering about 10% of the motor energy used during acceleration, spinning discharging and feeding. There are many batch centrifugals installed and operating using this 2 speed motor with braking from half speed by a large mechanical brake.

A further improvement resulted from the introduction of three speed motors, usually 3:2:1 speed ratio or thereabouts, using a single cage rotor in a double wound stator. Regenerative braking

then occurs to near one third speed recovering 20-25% of the motor energy used during acceleration etc. This results in a much smaller mechanical brake as the energy to be dissipated by the brake is proportional to the square of the speed at which the brake is applied. In one recent 1.3 tonne capacity centrifugal design the mechanical brake has been replaced by DC injection braking to give complete electrical braking, 85% of which is regenerative.

Inverter drives.

With the advent of electronic power inverters, particularly the pulse width modulated (PWM) type, the induction motor entered a new era. Given the variable frequency/voltage output of the inverter the induction motor could now operate at any speed above a few rpm to a top speed fixed by either the inverter maximum frequency or the motor rotor stresses, rather than a speed fixed by the supply frequency. Furthermore the special torque requirements for acceleration etc. of the single speed motor can now be provided electronically with some downrating at the lowest speed when the motor is self-cooled. The inverter driven motor still operates in the cyclic mode described above and therefore both motor and inverter need to be rated to suit this cyclic duty.

When applied to a centrifugal, acceleration is controlled by frequency/voltage change or torque/flux control within the allowed power to give the compromise between energy demand and centrifugal product processed. With an inverter capable of regeneration (4 quadrant type) deceleration is controlled in a similar way to the discharge speed and mechanical braking is only needed for emergencies.

Inverters are complex and expensive, typically 3.5 to 4 times the cost of the three speed induction motor controls and can create substantial harmonic distortion in the electric supply system when using diode/thyristor input power electronics. In the last few years this distortion has been substantially reduced using newer power electronic devices (IGBTs) increasing the cost to 4.5 to 5 times that of the three speed motor controls. Many modern centrifugals, particularly the larger units, are PWM inverter/induction motor driven.

For large multi-centrifugal installations a variant of the PWM inverter known as a common DC bus system (or sectional inverter) is becoming more common. In this system a battery of centrifugals is supplied through a single large input converter which converts the incoming AC supply to a DC supply. Each centrifugal motor is then supplied by a separate DC to AC inverter, each of which is supplied by the common DC bus. These 'single input - multiple output' inverters can provide advantages in terms of reduced harmonics induced in the main supply, reduced floor space requirement, and reduced costs. In practice, careful analysis of the design is necessary to ensure the expected economic benefits are realised. Generally some benefits accrue for installation of 4 or more large centrifugals.

Comparisons.

There are advantages and disadvantages with both three speed and inverter driven centrifugals. The comparisons below are taken from a series of tests on two centrifugals, identical except for the drive systems and operating on the same duty cycle. One centrifugal was fitted with a three speed regenerative induction motor with final braking by both mechanical braking and DC injection, the other centrifugal with a single speed induction motor fed by a proprietary PWM vector controlled inverter. Each centrifugal was fitted with a 1300mm diameter x 1070mm deep

basket of 1.3 tonnes massecuite capacity and capable of processing a maximum of 32 tonnes of massecuite per hour spinning at 1100xG. For testing purposes each basket was loaded with a fixed mass equivalent to a full massecuite/sugar load.

Peak current demand:

3 speed drive	110%
inverter drive	100%

Typical energy input per tonne of massecuite processed:

charges per hour	25	20	15	10
3 speed drive mechanical brake	1.5	1.7	1.9	2.2
3 speed drive DC injection brake	1.6	1.8	2.0	2.3
inverter drive	0.95	1.05	1.3	1.5

Cost comparisons - motor & controls:

3 speed (mechanical brake)	100%
3 speed (DC injection braking)	108%
inverter (diode/thyristor input)	180%
inverter (IGBT input)	215%

Supply harmonics

3 speed	negligible
inverter (diode/thyristor input)	severe. 35-45% current distortion.
inverter (IGBT input)	acceptable. 2-4% current distortion.

Figure 2 shows, for one cycle of 180 seconds, the energy supplied, energy returned via regeneration and the difference between the two (i.e. net energy demand) for a 3-speed and inverter drive. Estimated values for single and 2-speed drives are included for comparison. The progression to lower energy consumption as the number of speeds increases is clear.

Fig 2. Energy usage for various drive types.

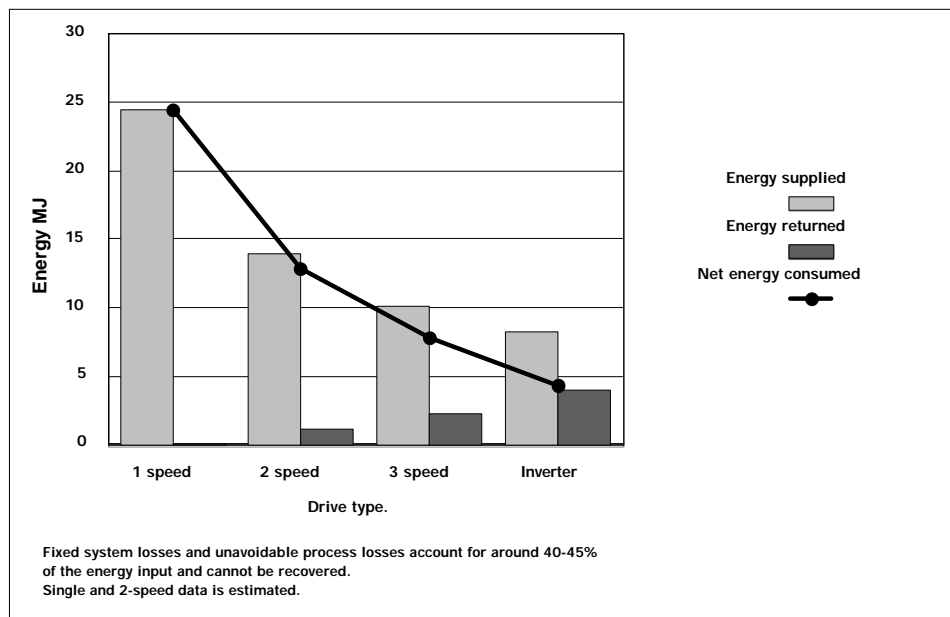

Graphs showing the supply current and speed on a cycle for a 3 speed with mechanical braking, 3 speed with DC injection braking and supply current and motor current for an inverter drive all on a 440 volts 60 HZ supply are shown in figures 3, 4, 5 & 6.

Fig 3. Speed and motor current against time for a 3 speed drive with mechanical brake.

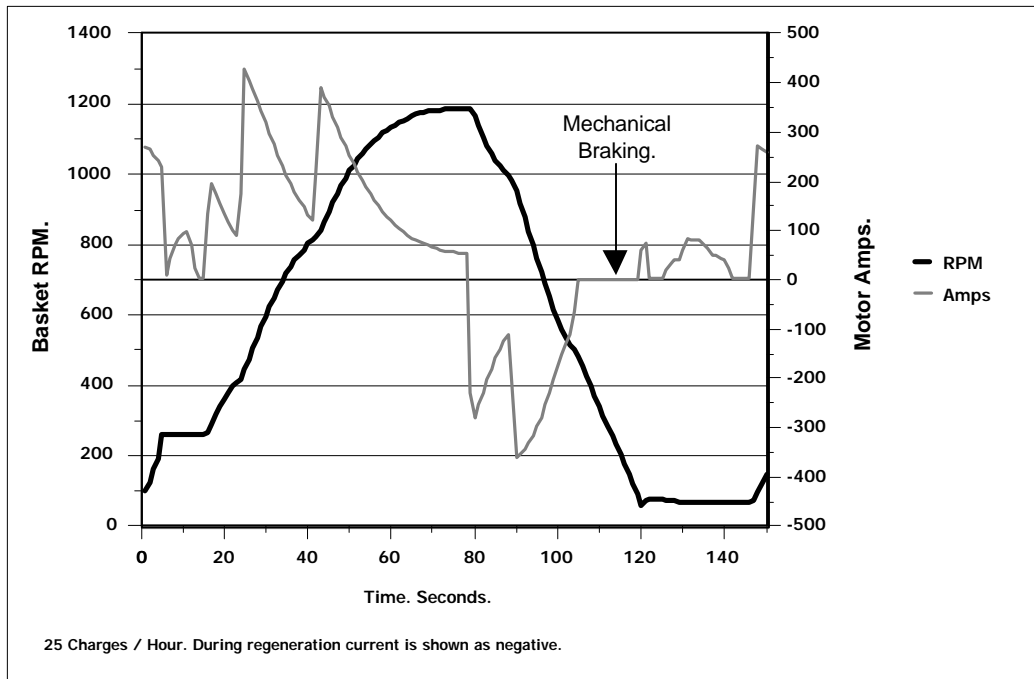

Fig 4. Speed and motor current against time for a 3 speed drive with DC electrical brake.

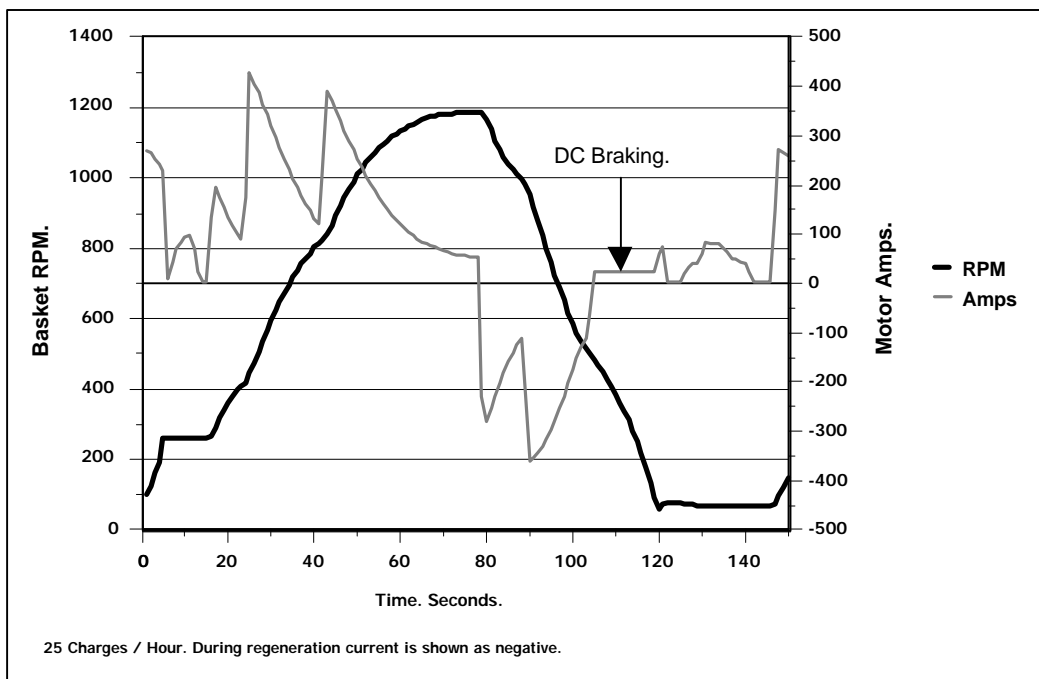

Fig 5. Speed and inverter input current against time for an inverter drive.

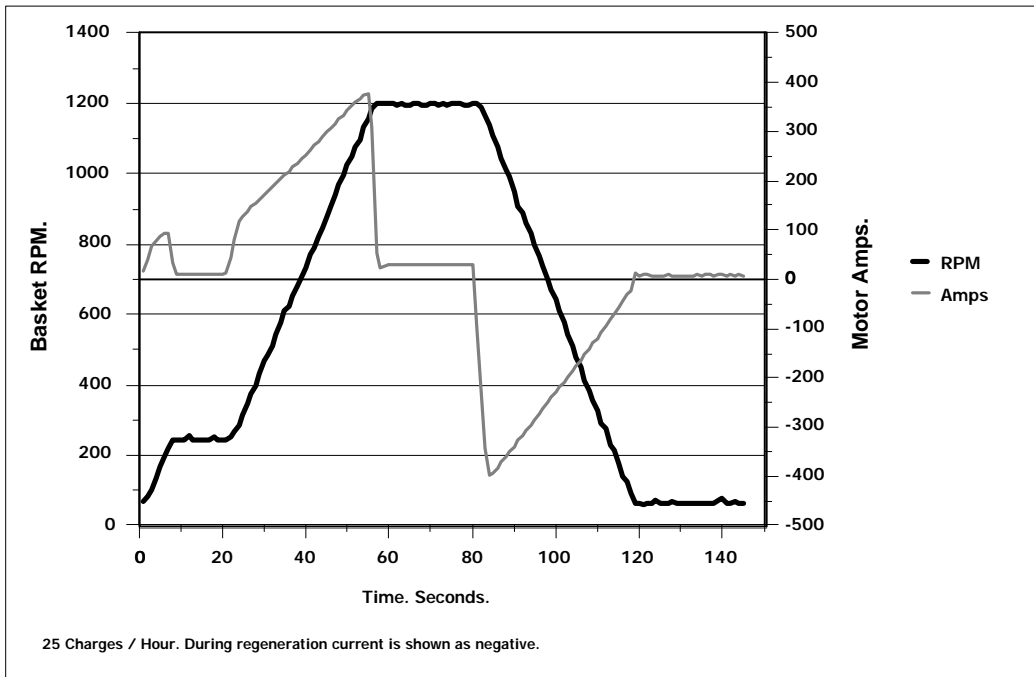
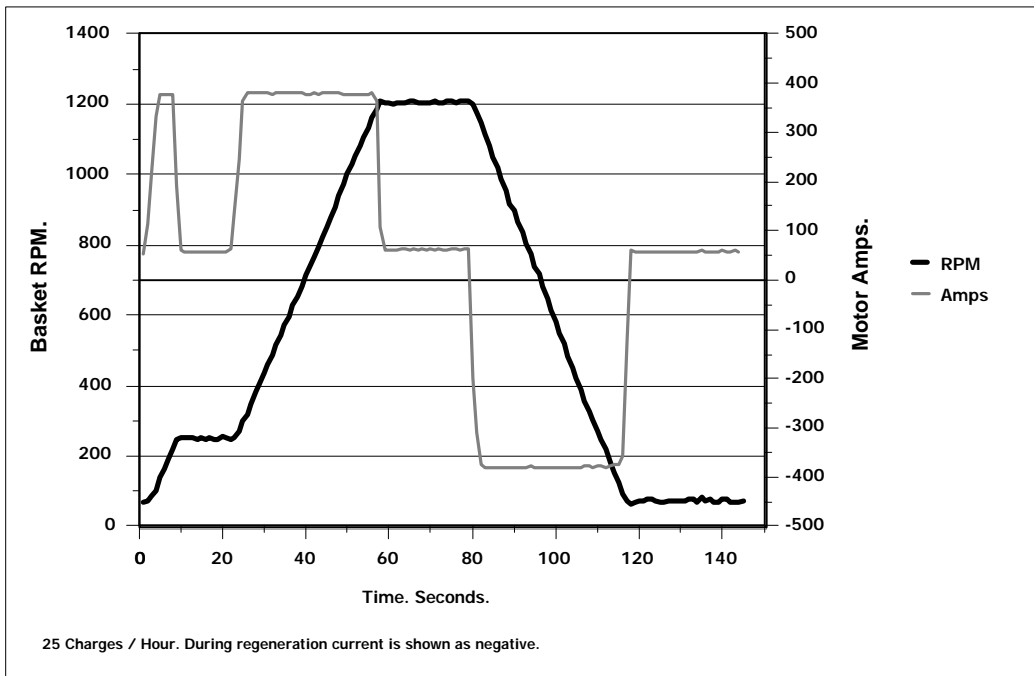

Fig 6. Speed and motor current against time for an inverter drive.



Site Experience.

In addition to these test results, experience in working with 3 speed and inverter drives in sugar factories is summarised below:

Performance.

This is much the same. The 3 speed drive has a higher initial acceleration rate but the rate slows as it approaches spin speed. The inverter allows the spin speed to be readily adjusted. In 3 speed motors this can only be achieved by changes to allow the centrifugal to coast when the required spin speed is reached (accompanied by a small increase in power demand).

Complexity.

Both drives use modern PLC process and sequence controls. The 3 speed motor controls are built from discrete conventional components (contactors, relays, timers, simple electronic circuits, etc.) connected together by a circuit arrangement within the understanding of a maintenance engineer. The inverter, although reliable, is an assembly of complex digital components requiring specialist electronic knowledge in the event of a problem, but offset by good built-in fault diagnostics.

The 3 speed motor has two windings in the stator slots compared with one for the inverter drive. Both stators are wound with conventional materials using conventional induction motor winding practice and both can be rewound, if necessary, by any electrical repair shop with the capacity to rewind motors up to 500kW.

Safety.

The avoidance of over-speeding is paramount. The 3 speed motor, spinning at a speed fixed by the input frequency is inherently safe. The variable frequency inverter drive is not, so that an inverter fault can lead to loss of speed control. At least two independent safety circuits are recommended to avoid overspeed and possible basket fracture. Similar speed control at discharge speed is advisable on both 3 speed and inverter drives. Other safety features (cover & discharge interlocks, earthing, sequencing, etc.) are common to both drives.

Cleanliness.

The inverter driven centrifugal does not use a mechanical brake during normal operation and is therefore 'cleaner' as there is no danger of contamination of the sugar by dust from the brake friction material. However some modern designs of multi-speed centrifugals now employ full electrical braking making them equivalent to inverter driven machines in terms of cleanliness.

Cables.

The 3 speed drive requires the same cable size to connect the supply to the control panel and the control panel to the motor - the cable being rated to the duty cycle. The cabling for the inverter drive is more complex. The rating of the incoming cable, in addition to the drive current, has to allow for the harmonics (as does any supply transformer). The PWM inverter supplies high constant current at variable voltage to the motor for acceleration and deceleration but draws variable current at constant voltage from the supply - see

figures 5 & 6. This means the motor cable has a current rating 40-60% higher than that required for the incoming cable. Local regulations may however dictate that the same size cable is used for both incoming and motor cables. Also the motor cable insulation has to withstand the higher peak ('spike') voltage output and avoid critical cable lengths - at which the repeated 'spike' can double the potential applied to the motor winding. This can cause premature failure or insulation 'fatigue', particularly for installations above 500v unless the motor winding insulation is upgraded or additional chokes are installed. It is not uncommon for supply transformers to be down rated by 15% to compensate for the harmonic currents present when using a diode/thyristor type inverter. A lesser down rating (perhaps 5%) is required for the more modern and expensive IGBT inverters.

Commissioning.

The 3 speed controls are relatively simple and require little or no site adjustment prior to commissioning. The more complex inverter drive may require some adjustment to match the inverter to the factory supply, the motor and the centrifugal duty cycle. This usually requires qualified electronic engineers to be present during commissioning to set up the inverter - a situation that may become more involved as inverter manufacturers add more parameters to achieve a 'universal' inverter design.

Other process factors affecting energy efficiency.

The efficient use of energy (i.e. low kWhours/tonne masse.) achieved in any batch centrifugal installation is an important economic factor and many papers have been published on the subject [e.g. Refs 2, 3]. However the energy advantages of a modern drive can be totally nullified and the energy demand seriously increased if close attention is not given to wash water usage for both screen and cake wash. The economic penalties of excess washing are large both in terms of energy necessary to evaporate the excess wash water and the sugar dissolution loss caused by the possible use of excess water [Ref 6]. The effectiveness of the centrifugal plough/discharge mechanism also has a significant affect on the sugar yield and therefore overall energy efficiency [Ref 4]. For a factory wide view of energy consumption see references 5, 7.

Conclusions.

Large centrifugals are well suited to inverter drives; in fact the inverter has allowed manufacturers to make larger basket centrifugals (e.g. 2.25 tonnes capacity) that are beyond the reach of realistic multi-speed motors. For medium sized centrifugals, however, both types are in competition and muti-speed drive have a place in the Sugar Industry. With little difference in process performance, the power costs and availability of capital together with considerations of possible harmonic interference and inherent complexity could be decisive. The two 1.3 tonne massequite centrifugals tested for the results above are a good example - from the operator platform they are identical in performance and appearance. Furthermore the latest design of the 3-speed drive tested above allows it to be converted to an inverter drive in the future with minimum disruption to the installed centrifugal.

References.

1. Variable frequency centrifugal drives - a convergence on converters.
James M. Coleman. Sugar y Azucar Pg 26 October 1995.
2. IEEE Transactions on Industry Application R.Osman & J.Bange.
Vol 27, No 6, Pg 1076-1080, Nov/Dec 1991.
3. Centrifugal variable speed drive installation at Savannah Sugar.
D.Zeigler. Int Sugar Jnl. Dec 1995, Vol 97, No 1164.
4. Process performance of a modern batch centrifugal.
P.D.Thompson & G.C.Grimwood. Int Sugar Jnl. Dec 1996, Vol 98, No 1176.
5. Aspects of energy consumption in sugar factory centrifugals.
P.Franzen. Int Sugar Jnl. 1991, Vol 93 No.1116.
6. Process performance of high capacity centrifugals.
G.C.Grimwood. P.D.Thompson. Int Sugar Jnl. Oct 1999, Vol 101, No 1210.
7. Reducing energy consumption in beet factories.
P.D.Thompson. Int Sugar Jnl. Aug 1999, Vol 101, No 1208.

Appendix.

A) Typical centrifugal duty cycles

Duty	Speed rpm	Time (seconds)		
		High Duty	Medium Duty	Low Duty
Accelerate to feed	60-250	6	6	6
Feed	250	12	15	18
Accelerate to spin	250-1200	35	35	35
Spin	1200	25	54	105
Decl. to discharge	1200-60	40	40	40
Discharge	60	25	30	35
Total cycle times		144	180	240
Charges per hour		25	20	15

B) Note on losses and efficiencies

To compare the efficiencies of the 3-speed and inverter drives it is necessary to sum the energy losses over a centrifugal cycle. The loss build up for the 3-speed and the inverter drive is shown in Fig.7.

For high duty centrifugals the total inverter energy loss per cycle is less than that of the 3-speed drive. However the higher motor and braking losses of the 3-speed drive are partially offset by the inverter losses being considerably larger than those of the simple motor controls required for 3-speed drives.

Inverter losses are notoriously difficult to estimate on a cyclic duty. A recent site test taken at points A and B on figure 7 measured kW hours per tonne of massecuite processed over a 40 minutes strike on a common DC bus system. The energy consumed at A was 0.95 and at B 1.25 kW hrs per tonne masse.

Whilst PWM inverters operate at 95%+ efficiency at power factors better than 0.9 this only applies to the industrial drives where the motor operates continuously at or near full load. Whilst these figures apply to the centrifugal drive during acceleration and deceleration they deteriorate for the low energy part of the cycle. The standing losses (i.e. the inverter power input at zero or low output) are substantial and 'weighted' efficiencies of the inverter only over a cycle of less than 85% have been recorded on high duty inverter driven sugar centrifugals.

As spin times are increased (charges per hour reduced) the 'weighted' inverter efficiency drops. Overall inverter efficiencies depend quite strongly on the configuration of the inverter and also vary between inverter suppliers.

Fig 7. Loss build up for multi-speed and inverter drive systems.

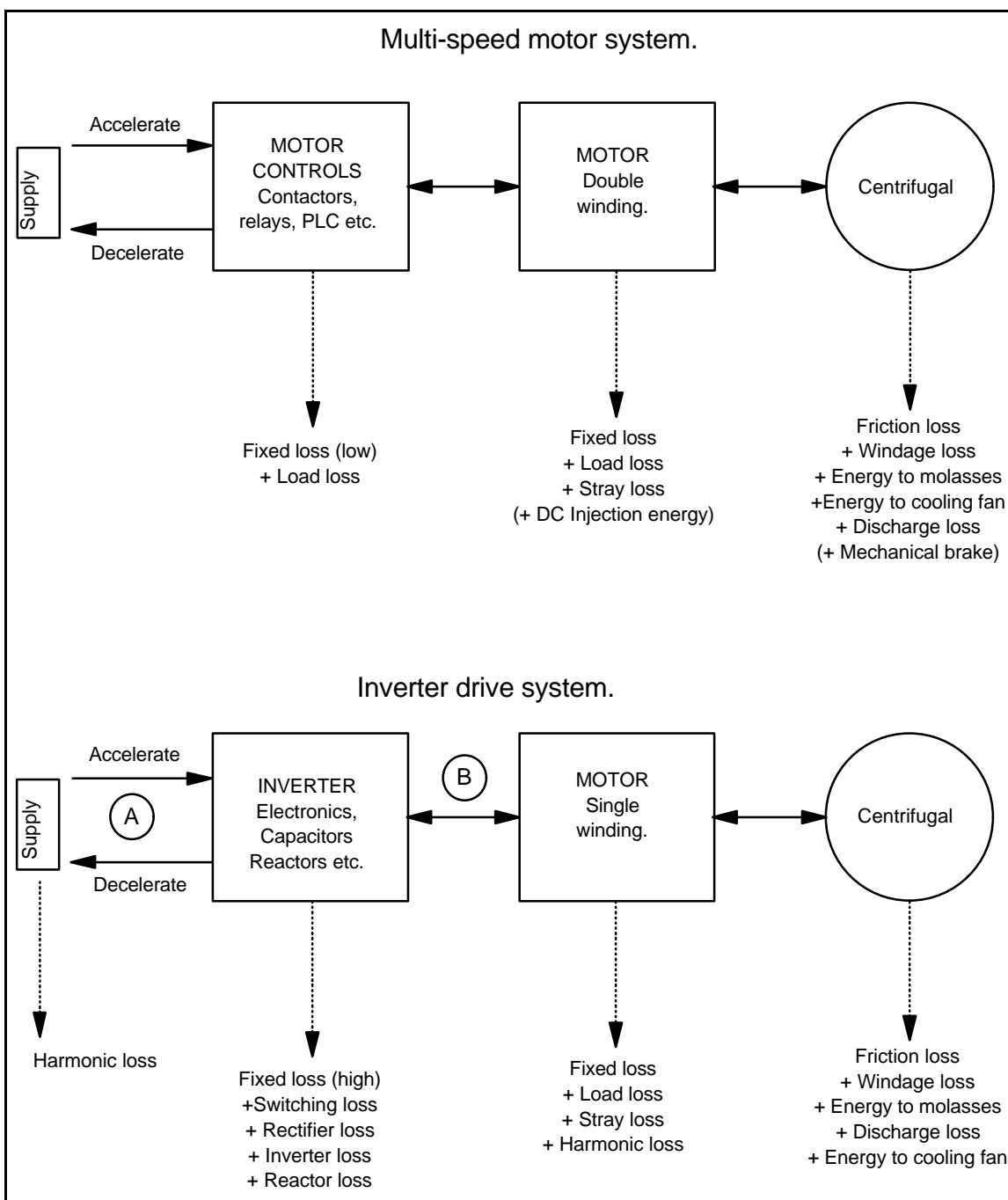

C) Plough direction.

The basket rotation direction for discharge has a marked effect on the power consumption for both types of drives. If discharge is made in the reverse direction to spinning then the deceleration of the centrifugal through zero speed to the reverse discharge speed, together with the increase in cycle time lost in reversing the rotation, adds 7 to 9% to the energy demand (kWhrs per tonne).